

Guideline for Excess Dimension

- . Vehicles Carrying Indivisible Articles**
- . Special Purpose Vehicles**
- . Vehicles that require a Pilot or Escort**

in Queensland

**Form Number 4
Version 7
February 2012**

TABLE OF CONTENTS

SECTION	CONTENT	PAGE
1	Guideline Authority	4
2	Commencement Date.....	4
3	Definitions.....	4
4	Application.....	7
5	Nil requirement for pilot/escorts – Dimension limits & loading requirements. (daytime travel)	8
	5.1 Dimension limits - Trucks, truck and pig, dog, tag trailer, prime mover and trailing group.....	8
	5.2 Loading requirements -Trucks and trucks hauling one trailer	9
	5.3 Rear overhang - Prime mover semitrailer combinations.....	9
	5.4 Dimension limits – Road trains and B-doubles	9
	5.5 Loading requirement and approved routes - Road trains and B-doubles	10
	5.6 Additional travel restrictions for road trains and B-doubles.....	11
	5.7 Dimension limits - Special purpose vehicles and combinations.....	11
6	Requirement for pilot/escort/police – Dimension limits (daytime travel).....	12
	6.1 Dimension limits – Trucks, trucks hauling a pig or dog or tag trailer, prime mover semi trailer combinations – do not require police permits.....	12
	6.2 Pilot and escort requirements – width and length	12
	6.3 Pilot or escort or police escort requirements -height	13
	6.4 Rear overhang – prime mover semitrailer combinations	13
	6.5 Critical area and critical road requirement	14
7	Requirements for nighttime travel.....	14
	7.1 Nighttime travel Trucks, trucks hauling a pig or dog or tag trailer, prime mover semi trailer combinations – do not require police permits.....	14
	7.2 Nighttime travel– police permits	15
	7.3 Nighttime travel – Road trains and B-doubles	15
8	Oversize vehicle or combination requirements.....	15
	8.1 Checking the route in advance	15
	8.2 Minimising Width	15
	8.3 Unladen travel prime movers and trailing group combinations.....	16
	8.4 Safe loading	16
	8.5 Carrying more than one indivisible article or general cargo with another Indivisible article	17
	8.6 High articles.....	17
	8.7 Long articles	18
	8.8 Speed limits.....	18
	8.9 Build up of traffic.....	18
	8.10 No Travel in low visibility.....	18
	8.11 Minimum following distance for all oversize vehicles.....	18
	8.12 Convoy operations.....	19
	8.13 Communication requirements for drivers of oversize vehicles or Combinations.....	19
	8.14 Directions from a pilot or escort driver	19
	8.15 Damage caused by oversize vehicles – drivers of oversize vehicles or Combination responsibility.....	19
	8.16 Road closures / Restrictions.....	19
	8.17 Required number of pilot and escort vehicles.....	19
	8.18 Excess mass	20
9	Approvals from other authorities.....	20
	9.1 General dimension approvals.....	20
	9.2 General dimension approvals from the Department of Transport and Main Roads	20

	9.3	General dimension approvals from Queensland Police Service	21
	9.4	General dimension approvals from electrical authorities	21
	9.5	General dimension approvals from telecommunication authorities	21
	9.6	General dimension approvals from Queensland Railway	21
	9.7	General dimension approvals for any miscellaneous major risk factor	21
10		Travel restrictions	22
	10.1	City of Brisbane or any other city	23
	10.2	Queensland – south east corner	23
	10.3	Statewide restrictions	23
	10.4	Christmas and New Year restrictions	24
	10.5	Easter restrictions	24
	10.6	Electrical authorities map – State of Queensland	25
11		Warning devices for oversize vehicles or combinations and pilot/escort vehicles	26
	11.1	Warning devices required when exceeding width	26
	11.2	Warning devices required when exceeding length	26
	11.3	Warning devices required when exceeding height	26
	11.4	Warning devices required when exceeding rear overhang	27
	11.5	Warning devices required when exceeding forward projection	27
	11.6	Additional warning devices required during nighttime travel	27
	11.7	Warning devices required for pilot and escort vehicles	28
12		Warning device specifications for oversize vehicles or combinations and pilot/escort vehicles	28
	12.1	Warning flags	28
	12.2	Warning lights	28
	12.3	Wig wag lights for escort vehicles only	29
	12.4	Delineators	29
	12.5	Warning signs	29
	12.6	Warning pattern	32
	12.7	Traffic cones	32
13		Pilot/escort, vehicle and operating requirements	32
	13.1	Pilot and escort vehicle requirements	33
	13.2	Lead pilot or escort vehicles	33
	13.3	Positioning of pilot/escort and assisting vehicles	33
14		Level 1 pilot and level 2 escort driver requirements	40
	14.1	Level 1 pilot and level 2 escort vehicle driver requirements	40
	14.2	Communication responsibilities	41
	14.3	Damage caused by oversize vehicles	41
	14.4	Record of movement	41
	14.5	No travel in low visibility	41
	14.6	Hand gestures	42
	14.7	Interstate level 1 pilot and level 2 escort drivers – mutual recognition	43
15		Traffic control recommendations	43
	15.1	Duties of level 2 escort vehicle driver performing traffic control	43
	15.2	Position of level 2 escort vehicle driver during traffic control	44
	15.3	Position of an escort vehicle during traffic control	44
	15.4	Warning traffic to stop	45
	15.5	Directing traffic to proceed	46
	15.6	Warning traffic to slow down	46
	15.7	Clothing requirements for traffic controllers	46
	15.8	Traffic control signals and equipment	47

1. Guideline Authority

This guideline is issued under Section 48 of the *Transport Operations (Road Use Management – Mass, Dimensions and Loading) Regulation 2005* in accordance with Part 4 Section 22 and Part 6 Section 47 of the *Statutory Instruments Act 1992*.

The following guideline is repealed:

- *Guideline for Excess Dimension-Vehicles Carrying Indivisible Articles, Special Purpose Vehicles, Vehicles that require a Pilot or Escort in Queensland – Form Number 4, Version 6 November 2010.*

2. Commencement Date

This form commenced on 17 February 2012.

3. Definitions

For the purpose of this guideline:

"ADR (Australian Design Rule)" means a national standard under the *Motor Vehicle Standards Act 1989* (Cwlth).

"built-up area", in relation to a length of road, means an area in which there are buildings on land next to the road, or there is street lighting, at intervals not over 100m for a distance of at least 500m, or if the road is shorter than 500m, for the whole road.

"Brisbane Urban Corridor" means the route between Archerfield and Wishart consisting of Mt Gravatt-Capalaba Road west of the Gateway Motorway, Kessels Road, Riawena Road, and Granard Road.

"Central Business District" means the network of roads that are located within the regulated parking zone of any city.

The term **"city"** includes any place within the city limits of the following towns or cities listed and are not limited to the Central Business District of any such place. The towns or cities included are: Brisbane, Bundaberg, Caboolture, Cairns, Caloundra, Gladstone, Gold Coast, Ipswich, Logan City, Mackay, Maryborough, Mount Isa, Rockhampton, Townsville, and Toowoomba.

"combination" means a prime mover or truck connected to one or more trailers.

"converter dolly" means a trailer with one axle group or single axle and a fifth wheel coupling designed to convert a semitrailer into a dog trailer.

"daytime" means the period beginning at sunrise and ending at sunset or where visibility is not less than 250m due to natural light.

"dog trailer" means a trailer that has 2 axle groups with the front axle group being steered by connection to the towing vehicle.

"dolly" means a specially designed pig trailer used to convert a semitrailer into a dog trailer.

"driver" means the person driving or in control of a motor vehicle.

"escort vehicle driver (level 2) " means a person who holds an appointment under Part 2 of the *Transport Operations (Road Use Management – Accreditation and Other Provisions) Regulation 2005* as an accredited person with the functions of an escort vehicle driver. A police officer is not an escort vehicle driver. Note – The term level 2 will be used for the purpose of this guideline only.

"escort vehicle" means a vehicle that is required to be driven by a level 2 escort vehicle driver to warn other road users of the oversize vehicle's presence.

An **"indivisible article"** is one that cannot be divided without extreme effort or expense or risk of damage to it.

"jinker" means an axle or axle group which is built to support part of a load, and is connected to the vehicle in front of it by a pole, or cable, or the load itself, if any.

"low loader" means a gooseneck semitrailer with a loading deck no more than 1.2m above the ground.

"low loader dolly" means a mass distributing device that:

- (a) is usually coupled between a prime mover and a low loader; and
- (b) consists of a gooseneck rigid frame; and
- (c) does not directly carry any load on itself; and
- (d) is equipped with one or more axles, a kingpin and a fifth wheel coupling.

"nighttime" means the period beginning at sunset and ending at sunrise or where visibility is less than 250m due to natural light.

"operator" means a person who controls or directs the operations of a combination, or a motor vehicle not forming part of a combination, or who is otherwise responsible for it.

"oversize vehicle or combination" means a vehicle or combination, including the dimension of any load, that does not comply with Part 3 of the *Transport Operations (Road Use Management – Mass, Dimensions and Loading) Regulation 2005*.

"pig trailer" means a trailer with 1 axle group near the middle of its load carrying surface and connected to the towing vehicle by a drawbar.

"pilot vehicle driver (level 1)" means a person who holds an appointment under Part 2 of the *Transport Operations (Road Use Management – Accreditation and Other Provisions) Regulation 2005* as an accredited person with the functions of a pilot vehicle driver. A police officer is not a pilot vehicle driver.

Note – The term level 1 will be used for the purpose of this guideline only.

"pilot or escort operation" includes any operation where a pilot, escort or police officer, accompanies an oversize vehicle or combination in accordance with any guideline, permit or other lawful authorisation.

"pilot vehicle" means a vehicle that is required to be driven by either a level 1 pilot vehicle driver, a level 2 escort vehicle driver or by another person stated in this guideline or permit, to warn other road users of the oversize vehicle's presence.

"prime mover" means a motor vehicle designed to tow a semitrailer.

"rear overhang" of a vehicle is the distance between the rear of the vehicle and the rear overhang line of the vehicle.

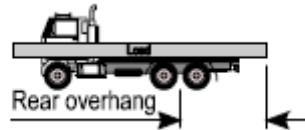

"rear overhang line" is the centre of the rear most axle, or the centre of the rear most axle group. The term is defined under Part 3 of the *Transport Operations (Road Use Management – Mass, Dimensions and Loading) Regulation 2005*.

Examples of rear overhang include:

Single axle



Two axles fitted with equal number of tyres



Three axles



"road train" means a vehicle, other than a B-double, that operates under the *Guideline for Multi-combination Vehicles in Queensland Form Number 1*.

"semitrailer" means a trailer (including a pole type trailer) that has 1 axle group towards the rear, and a way of attaching to a prime mover, that results in some of the load being imposed on the prime mover.

"special purpose vehicle" means a vehicle, other than a tow truck or agricultural vehicle, built for a purpose other than carrying a load, except for auxiliary equipment, water or other substances which are directly associated with the operation of the vehicle (e.g. mobile crane, drilling rig, concrete pump, travel tower, front end loader, forklift, fire trucks etc).

"special purpose combination" means a prime mover semitrailer combination, other than a tow truck or agricultural vehicle, built for a purpose other than carrying a load, except for auxiliary equipment, water or other substances which are directly associated with the operation of the vehicle (e.g. drilling rig or tub grinders).

"south east corner" means the area bounded by Coolangatta in the south, Gympie in the north, Toowoomba and Warwick in the west.

"tag trailer" means a semitrailer that does not impose a load on the front axle or axle group of the towing vehicle.

"truck" means a motor vehicle with a GVM over 4.5t, other than a bus, tractor or tram.

"vehicle" includes anything the vehicle carries that is essential for its operation.

4. Application

This guideline is issued as an alternative means of complying with Part 3 Vehicle dimensions of the *Transport Operations (Road Use Management – Mass, Dimensions and Loading) Regulation 2005*. Included in the guideline is the level 1 pilot and level 2 escort vehicle driver requirements that pilot and escort vehicle drivers must comply with.

To operate under this guideline a vehicle must have a gross vehicle mass (GVM) of more than 4.5t or be in a combination that includes a vehicle with a GVM of more than 4.5t.

This guideline applies to:

- operators of complying vehicles or combinations that exceed regulated dimensions when loaded with indivisible articles; and
- operators of special purpose vehicles that exceed regulated dimensions; and
- operators of low loaders that by construction, exceed regulated dimensions when not laden and that are used for the carriage of indivisible articles; and
- operators of road trains or B-double combinations that exceed regulated height and width dimensions when loaded with indivisible articles; and
- operators of special purpose vehicles, as well as operators of vehicles transporting indivisible articles, at dimensions which require level 1 pilot or level 2 escort drivers.

It exempts:

- a truck or a truck hauling a trailer when laden with an indivisible item from the requirements of Section 25 (Width), s26 (Height), s34(2)(b)(ii)(iii) (Limits on projection of loads) of the *Transport Operations (Road Use Management – Mass, Dimensions and Loading) Regulation 2005*; and
- a prime mover semitrailer combination exceeding 19m in length and/or 2.5m in width when laden from the requirements in Section 25 (Width), s26 (Height), s28(1)(2) (Length-trailers), s29(2)(a) (Length-rear overhang), s34(2)(b)(ii)(iii)

(Limits on projection of loads) of the *Transport Operations (Road Use Management – Mass, Dimensions and Loading) Regulation 2005*; and

- a low loader combination from the requirements in Section 25 (Width), s26 (Height), s28(1)(2) (Length-trailers), s29(2)(a) (Length-rear overhang), s34(2)(b)(ii)(iii) (Limits on projection of loads) of the *Transport Operations (Road Use Management – Mass, Dimensions and Loading) Regulation 2005*; and
 - a special purpose vehicle or special purpose combination from the requirements of Section 25 (Width), s26 (Height), s28 (Length-trailers), s29 (Length-rear overhang) of the *Transport Operations (Road Use Management – Mass, Dimensions and Loading) Regulation 2005* unless otherwise restricted in this guideline; and
 - a road train or B-double combination exceeding 2.5m in width when laden, is exempt from the requirements in Section 25 (Width), s26 (Height), s34(2)(b)(iii) (Limits on projection of loads) of the *Transport Operations (Road Use Management – Mass, Dimensions and Loading) Regulation 2005*.
- 4.1** Escort operations can be conducted by police service officers and accredited level 2 escort vehicle drivers appointed by the Chief Executive of the Department of Transport and Main Roads under Section 21 (Appointment of accredited persons) of the *Transport Operations (Road Use Management) Act 1995*.
- 4.2** Pilot operations can be conducted by accredited level 1 pilot vehicle drivers and accredited level 2 escort vehicle drivers appointed by the Chief Executive of the Department of Transport and Main Roads to carry out level 1 pilot duties under Section 21 (Appointment of accredited persons) of the *Transport Operations (Road Use Management) Act 1995*.
- 4.3** A police officer is not bound to comply with the provisions of this guideline when assisting in any level 1 pilot or level 2 escort operations, and cannot commit an offence against Section 20 (Offence to drive pilot vehicle) and Section 23 (Offence to drive escort vehicle) of the *Transport Operations (Road Use Management – Accreditation and Other Provisions) Regulation 2005*.
- 4.4** The movement of excess dimension agricultural vehicles and agricultural combinations is not authorised by this guideline. Refer to the current version of the *Guideline for Excess Dimension Agricultural Vehicles and Agricultural Combinations Vehicles and Drivers - Form Number 14*.
- 4.5** This guideline does not exempt the user from obtaining any permit, or other authority, or complying with the provisions of any other law.
- 4.6** All vehicles must have current registration, or be operating under an authorisation issued under section 107 of the *Transport Operations (Road Use Management—Vehicle Registration) Regulation 2010*.
- 5. Nil requirement for pilots/escorts - Dimension limits & loading requirements. (daytime travel)**
- 5.1 Dimension limits – Trucks, trucks hauling a pig or dog or tag trailer, prime mover semi trailer combinations.**

- 5.1.1** The overall maximum dimensions and vehicles that apply are listed in Table 1:

Table 1

Type of Vehicle or Combination carrying indivisible article	Dimension	Limits
Trucks	Length Height Width	12.5m 4.6m 3.5m
Trucks hauling one trailer (includes a pig trailer, dog trailer or tag trailer)	Length Height Width	19.0m 4.6m 3.5m
Prime mover semitrailer combination (includes drop decks, low loaders, low loader dollies, jinkers, extendable trailers and platform trailers)	Length Height Width	25.0m *5.0m 3.5m *see note

Note: Please refer to section 8 of this guideline if height is exceeding 4.6m

5.2 Loading requirements - Trucks and trucks hauling one trailer

- 5.2.1** In instances where only one indivisible article is to be carried, it must be carried on the truck and not on the trailer. This subsection does not apply to a truck hauling a tag trailer.
- 5.2.2** In instances where more than one indivisible article is to be carried, it is permissible to carry excess dimensional indivisible articles on the truck and on the trailer.

5.3 Rear overhang - Prime mover semitrailer combinations

- 5.3.1** The distance from the rear overhang line to the rear of the load is not to be greater than the lesser of:
- (a)** 5.5m; or
 - (b)** 25% of the total vehicle combination length.

5.4 Dimension limits - Road trains and B-doubles

- 5.4.1** The overall maximum dimension limits applicable for road trains and B-doubles operating on approved road train routes carrying indivisible articles are listed in Table 2:

Table 2

Type of vehicle or combination carrying indivisible articles	Dimension	Limits
Road trains and B-doubles	Length Height Width	As per maximum length in the <i>Guideline for Multi-combination Vehicles</i> 4.6m 3.2m
Road trains and B-doubles	Length Height Width	As per maximum length in the <i>Guideline for Multi-combination Vehicles</i> 4.8m 2.5m

5.5 Loading requirement and approved route – Road train and B-double.

5.5.1 A road train or B-double combination may carry indivisible articles to a width of 3.2m and/or height of 4.6m or to a width of 2.5m and/or height of 4.8m only on the following combinations as listed in Table 3:

Table 3

Type of combination carrying an indivisible article	Vehicles permitted to carry indivisible articles to a width of 3.2m and/or a height of 4.6m	Approved route where permitted to operate
Type 1 prime mover and semitrailer road train combination	All trailers	Type 1 and Type 2 road train routes
Type 2 prime mover and semitrailer road train combination	First and second trailer	Type 2 road train routes
Type 1 road train combination with rigid truck hauling unit	Truck and trailer	Type 1 and Type 2 road train routes
Type 2 road train combination with rigid truck hauling unit	Truck and first trailer	Type 2 road train route
B-double	All trailers	Type 1 and Type 2 road train routes
Type of combination carrying an indivisible article	Vehicles permitted to carry indivisible articles to width of 2.5m and/or a height of 4.8m	Approved route where permitted to operate
A road train or B-double combination	Any rigid truck or trailer of the combination	B-doubles and Type 1 road trains on Type 1 and Type 2 road train routes. Type 2 road trains on Type 2 road train routes only

5.5.2 Indivisible articles to a width of 3.5m and total height to 4.85m for a Type 1 road train and to 3.2m wide and total height to 4.85m high for a Type 2 road

train may be transported on the Barkly Highway between the Queensland/Northern Territory border and Camooweal.

- 5.5.3** A road train or B-double combination which exceeds the dimensions in this guideline must be broken down so as all individual vehicle combinations conform to this guideline or the regulation dimensions.

5.6 Additional travel restrictions for road trains and B-doubles

- 5.6.1** A Type 1 road train or B-double combination carrying indivisible articles wider than 2.5m to a width of 3.2m on all trailers or truck and trailer combinations, must be accompanied by one pilot vehicle in accordance with the conditions specified in section 15 of this guideline when travelling on the Warrego Highway between Toowoomba and the Chinchilla Shire boundary (approximately 3km north west of Warra).
- 5.6.2** Vehicles operating in accordance with subsection 5.6.1 are exempt from the requirement of being accompanied by a pilot vehicle if an oversize indivisible article is being carried on only the first trailer of the combination, or in instances of a truck and trailer road train combination, the truck only.
- 5.6.3** A Type 2 road train travelling on the Barkly Highway, between Cloncurry and Mt Isa may only carry an indivisible article wider than 2.5m to a width of 3.2m on the first trailer of the combination or in instances of a truck and trailer road train combination the truck only.

5.7 Dimension limits - Special purpose vehicles and combinations

- 5.7.1** The overall maximum dimensions applicable for special purpose vehicles are as follows in Table 4:

Table 4

Type of vehicle or combination carrying indivisible articles	Dimension	Limits
Special purpose vehicles	Length	14.5m
	Height	4.6m
	Width	3.5m
Mobile cranes	Length	19.0m
	Height	4.6m
	Width	3.5m
Special purpose combinations (drilling rigs, tub grinders or similar machinery.)	Length	25.0m
	Height	4.6m
	Width	3.5m

- 5.7.2** The distance from the rear overhang line to the rear of a special purpose vehicle must not be greater than the lesser of:
- (a)** 4m; or
 - (b)** 90% of the wheelbase.
- 5.7.3** The distance from the rear overhang line to the rear of a special purpose combination is not to be greater than the lesser of:
- (a)** 5.5m; or

(b) 25% of the total vehicle combination length.

5.7.4 The projection forward of the centre of the steering wheel of a mobile crane must not be greater than 5.4m.

5.7.5 The projection forward of the centre of the steering wheel of a special purpose vehicle, other than a mobile crane, must not be greater than 3.5m.

5.7.6 A special purpose vehicle must minimise its dimension as far as practicable for road travel.

5.7.7 A mobile crane less than 3m wide is exempt from the vehicle requirements in subsection 11.1.1 of this guideline.

6. Requirement for pilot/escort/police - Dimension limits (daytime travel)

6.1 Dimension limits – Trucks, trucks hauling a pig or dog or tag trailer, prime mover semi trailer combinations – do not require police permits.

6.1.1 The overall maximum dimensions in Table 5 apply to the following vehicles when accompanied by the required level 1 pilot/level 2 escort driver or police officer.

Table 5

Type of vehicle or combination	Dimension	Limits
Trucks	Length	12.5m
	Height	4.6m
	Width	5.5m
Trucks hauling one trailer (includes a pig trailer, dog trailer or tag trailer)	Length	19.0m
	Height	4.6m
	Width	5.5m
Prime mover semitrailer combination (includes drop deck, low loaders, low loader dollies, jinkers, extendable trailers and platform trailers)	Length	35.0m
	Height	*5.0m
	Width	5.5m

* Please refer to section 8 of this guideline if height is exceeding 4.6m.

- Police permits are required for width over 4.5m when operating on critical roads and roads in critical areas.

6.2 Pilot or escort or police escort requirements – width and length

6.2.1 Table 6 depicts the minimum level 1 pilot or level 2 escort or police escort required when accompanying an oversize vehicle or combination.

6.2.2 The requirements of Table 6 do not include critical areas, critical roads and major roads. Additional pilot/escort and/or police escorts are required as per 6.3 or the *Critical Areas and Roads in Queensland for Vehicles/Combinations Requiring Pilot/Escort map*, or a police permit.

Table 6

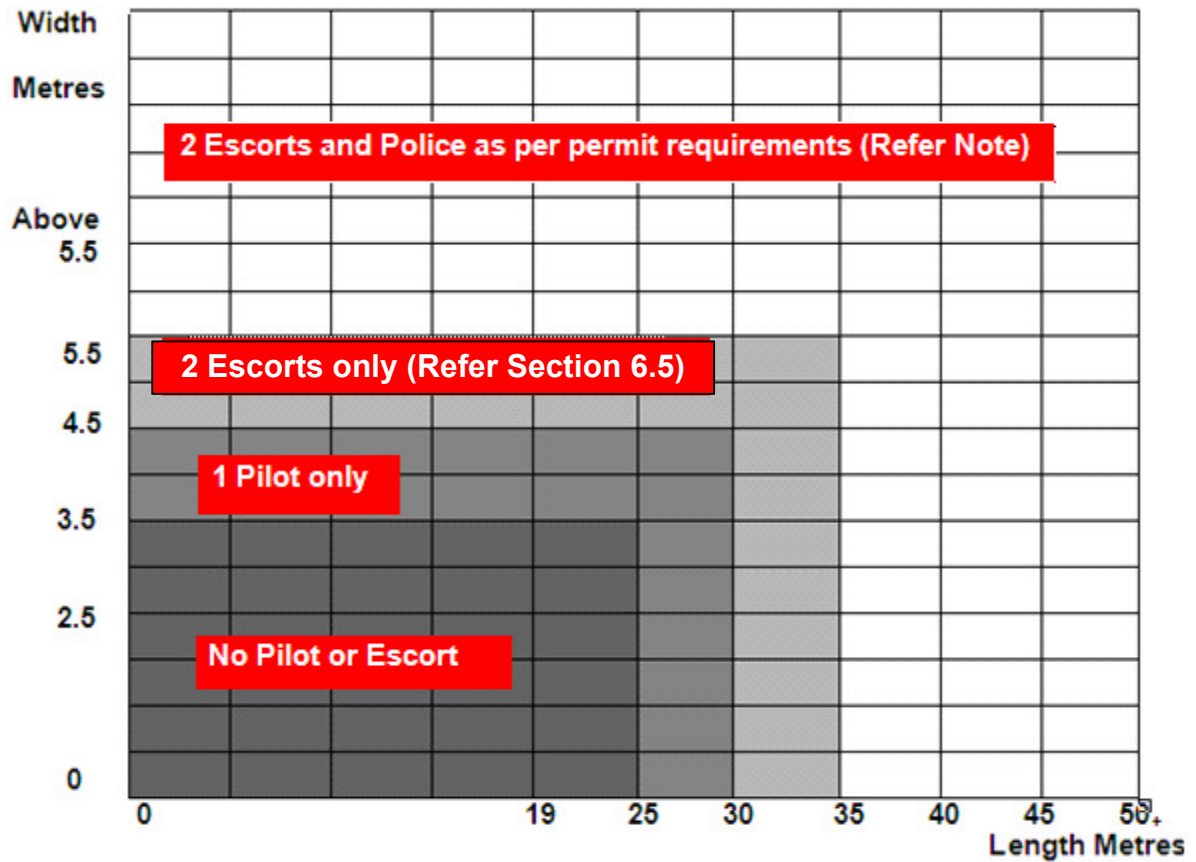

Note: Sub section 13.3 indicates a recommended position or maximum distance a pilot or escort or police escort vehicle should travel when accompanying an oversize vehicle or combination.

6.3 Pilot or escort or police escort requirements – height

6.3.1 A prime mover semitrailer combination operating at a width and/or length dimension that requires a level 1 pilot/level 2 escort driver or police escort, is permitted to operate to a height of 5m provided the vehicle is being accompanied by the required level 1 pilot/level 2 escort driver/police escort necessary for daylight hours.

6.4 Rear Overhang – prime mover semitrailer combinations.

6.4.1 A prime mover semitrailer combination operating at a width and/or length dimension that requires a level 1 pilot/level 2 escort driver or police escort for daytime travel must not exceed the following rear overhang that applies to the combination length as specified in Table 7:

Table 7

Combination length		Rear overhang
Longer than	Not longer than	Up to
25.00m	25.25m	6.82m
25.25m	25.50m	6.89m
25.50m	25.75m	6.95m
25.75m	26.00m	7.02m
26.00m	26.25m	7.09m
26.25m	26.50m	7.16m
26.50m	26.75m	7.22m
26.75m	27.00m	7.29m
27.00m	27.25m	7.36m
27.25m	27.50m	7.43m
27.50m	27.75m	7.49m
27.75m	28.00m	7.56m
28.00m and longer		7.60m

6.5 Critical area and critical road requirement.

6.5.1 An oversize vehicle or combination mentioned in Table 5 which exceeds 4.5m in width, up to a maximum of 5.5m in width, is permitted to travel during daylight hours in a critical area or on Type A or Type B roads whilst complying with the following requirements:

- (a) Type A roads (marked red) require no less than 1 police escort vehicle and 2 escort vehicles; and
- (b) Type B roads (marked blue) require no less than 3 escort vehicles; and
- (c) Critical areas (areas coloured in green) require no less than 1 police escort vehicle and 2 escort vehicles.

Note: A copy of the map is available by purchasing a hard copy of this guideline at the Queensland Government Bookshop, phone (07) 3118 6900, or 1800 679 778, or www.bookshop.qld.gov.au.

7. Requirements for nighttime travel

7.1 Nighttime travel Trucks, trucks hauling a pig or dog or tag trailer, prime mover semi trailer combinations – do not require police permits.

7.1.1 An oversize vehicle or combination that does not exceed 3.1m in width and/or 25m in length is permitted to travel at nighttime, unless otherwise restricted in this guideline.

7.1.2 An oversize vehicle or combination exceeding the dimensions mentioned in subsection 7.1.1 is permitted to travel up to 7.00pm provided:

- (a) the oversize vehicle or combination is being escorted by pilot or escort vehicles as required for daytime travel; and
- (b) the journey commences in daytime; and

- (c) the journey being undertaken can be completed by 7.00pm; and
- (d) the level 1 pilot or level 2 escort driver reasonably considers that to do so would be safe, having regard to road and traffic conditions, and would not unreasonably inconvenience the public.

7.1.3 An oversize vehicle or combination exceeding the dimension requirements mentioned in subsection 7.1.1 is permitted to travel within the boundary of the city of Brisbane or within the boundary of any other city from 12.00am provided:

- (a) the oversize vehicle or combination is being escorted by pilot or escort vehicles as required for daytime travel; and
- (b) the level 1 pilot or level 2 escort driver responsible, considers that it is necessary to do so to complete the journey being undertaken on that day, or to be out of the city boundary by 7.00am; and
- (c) the oversize vehicle or combination is being escorted by at least 1 pilot or escort vehicle driving in front, and 1 pilot or escort vehicle driving behind.

7.2 Nighttime travel – Police permits

7.2.1 Despite subsections 7.1 and 7.2, police permits are required for all other nighttime movements.

7.2.2 The permit will specify the required number of level 1 pilot/level 2 escort drivers and any operating requirements.

7.3 Nighttime travel – Road trains and B-doubles

7.3.1 Transportation of indivisible articles on road trains or B-double combinations wider than 2.5m is not permitted at nighttime

8. Oversize vehicle or combination requirements

8.1 Checking the route in advance

8.1.1 The person responsible for moving the load must ensure that the route is suitable for travel with a minimum inconvenience to other road users.

8.1.2 The person responsible for moving the load must obtain all relevant permissions, authorities or inquiries prior to the movement to ensure the movement of the oversize vehicle or combination does not pose a danger to property or other road users whilst travelling that route.

8.2 Minimising Width

8.2.1 If an indivisible article can be safely loaded in more than one way, it must be loaded in a way that minimises the width of the vehicle or combination and its load.

8.3 Unladen travel prime movers and trailing group combinations

- 8.3.1** An unladen load-carrying vehicle must be reduced to the smallest practicable dimensions. An unladen low loader, low loader dolly, platform or jinker is permitted to operate under the requirements of this guideline provided they are not constructed wider than:
- (a) 2.5m where there are 4 tyres on each axle; or
 - (b) 2.7m where there are 8 tyres on each axle; or
 - (c) 3.5m where the ATM is 100t or greater.
- 8.3.2** The distance from the rear overhang line to the rear of an unladen low loader combination must not be greater than 3.7m.
- 8.3.3** Despite subsection 8.3.2, the distance from the rear overhang line to the rear of the unladen low loader may exceed 3.7m provided:
- (a) the low loader has 4 or more axles; and
 - (b) the distance from the centre of the last 2 axles to the rear of the low loader is not greater than 3.7m.
- 8.3.4** The distance from the kingpin (articulation point) to the centre of the axle group (rear overhang line) for an unladen low loader may exceed 9.5m.
- 8.3.5** The deck length of an unladen low loader may exceed 13.7m in length.
- 8.3.6** A low loader dolly must not be towed in combination with an unladen low loader unless exceptional difficulties in loading or unloading the dolly exist due to the nature of the site or because of the short distance to be travelled.

8.4 Safe loading

- 8.4.1** A vehicle or combination must be loaded in a manner that ensures:
- (a) the risks to other road users are minimised; and
 - (b) the loading does not adversely affect the vehicle's stability; and
 - (c) the load on the vehicle is securely restrained by an appropriate method.*

* See the 'Load Restraint Guide' for examples of safe ways of loading vehicles. The 'Load Restraint Guide' is published by the National Transport Commission and may be accessed on the commission's website at <www.ntc.gov.au>.

8.5 Carrying more than one indivisible article or general cargo with another indivisible article

- 8.5.1** An oversize vehicle or combination must not carry additional indivisible articles unless:

- (a) the additional indivisible article does not cause the vehicle or combination and its load to exceed a dimensional limit in the *Transport Operations (Road Use Management – Mass, Dimensions and Loading) Regulation 2005*, that would not have been exceeded by the carrying of one of the indivisible articles; and
- (b) the vehicle or combination and its load complies with the mass limits in the *Transport Operations (Road Use Management – Mass, Dimensions and Loading) Regulation 2005*.

8.5.2 Subsection 8.4.1(b) does not apply if an excess mass combination is carrying equipment in addition to an indivisible article in accordance with the requirements of the *Guideline for Operation of Excess Mass, Special Purpose Vehicles to 40 tonnes and Vehicles Carrying an Indivisible Item to 59.5 tonnes Form Number 11* or an Excess Mass Permit.

8.5.3 An oversize vehicle combination may carry general cargo at the same time as an indivisible article provided:

- (a) the vehicle combination and its load complies with the mass limits in the *Transport Operations (Road Use Management – Mass, Dimensions and Loading) Regulation 2005*;
- (b) the loading space required for the general cargo does not exceed a dimension limit in the *Transport Operations (Road Use Management – Mass, Dimensions and Loading) Regulation 2005*; and
- (c) the additional general cargo does not cause the vehicle to exceed another regulation dimension limit contained in the *Transport Operations (Road Use Management – Mass, Dimensions and Loading) Regulation 2005*.

Note: An example of when an oversize vehicle cannot carry more than one indivisible article or general cargo is when the items are loaded:

- (a) side by side exceeding 2.5m in width; or
- (b) one above the other exceeding 4.3m in height; or
- (c) behind one another exceeding a regulation length limit (e.g. 12.5m on a rigid vehicle, 19m on a combination or rear overhang regulation limits).

8.6 High articles

8.6.1 An oversize vehicle or combination transporting an indivisible item may only be loaded higher than 4.8m if the load is transported on a low loader, stepdeck trailer, or a platform with a loading deck no more than 1.2m from the ground.

8.7 Long articles

8.7.1 An oversize vehicle combination transporting an indivisible article longer than 30m, must have a rear-end steering unit.

8.8 Speed limits

8.8.1 The maximum speed limit applying to a person driving an oversize vehicle or combination is:

- (a) 90km/h outside built up areas, except where official traffic signs indicate a lower speed limit; or
- (b) 80km/h outside built up areas, except where official traffic signs indicate a lower speed limit, when required to travel with a pilot or escort vehicle.

8.9 Build up of traffic.

8.9.1 Where the oversize vehicle or combination is travelling at a speed that causes a build up of traffic, the driver of the oversize vehicle or combination must take all reasonable steps to alleviate the build up of traffic. This does not include exceeding any posted speed limit or speed limit indicated in sub section 8.8.1 (a) and (b).

8.10 No travel in low visibility

8.10.1 The driver of an oversize vehicle or combination must not begin to travel, if due to circumstances such as glare, fog, heavy rain, smoke, dust or insect plague:

- (a) visibility is less than 250m in the daytime; or
- (b) the headlights of a vehicle approaching within 250m could not be seen at nighttime; or
- (c) visibility is sufficiently restricted that the safety of the pilot or escort operation, or other road users may be comprised.

8.10.2 If an oversize vehicle or combination is already travelling when visibility is reduced to the level described in subsection 8.10.1, the driver must drive to the nearest safe parking area and wait until visibility improves beyond that level before continuing to travel.

8.11 Minimum following distance for all oversize vehicles

8.11.1 The driver of an oversize vehicle or combination must maintain a distance of at least 200m from another oversize vehicle or combination travelling in front of it, unless:

- (a) it is overtaking the front vehicle and the front vehicle is stopping; or
- (b) it is overtaking the front vehicle and there is a separate lane available for the use of overtaking traffic; or
- (c) it is in an urban area and it is not practicable to maintain a distance of 200m.

8.12 Convoy operations

- 8.12.1** Oversize vehicles or combinations requiring pilot or escort vehicles, are permitted to operate in convoy formation if approved as a condition of a permit issued by the Queensland Police Service.

8.13 Communication requirements for drivers of oversize vehicles or combinations

- 8.13.1** The driver of an oversize vehicle or combination being accompanied by a pilot or escort vehicle must ensure two-way communication equipment is available in the oversize vehicle or combination. The communication equipment must be in working order allowing communication between the escorted vehicle and the pilot/escort vehicle.

8.14 Directions from a pilot or escort driver.

- 8.14.1** The driver of an oversize vehicle or combination shall comply with any lawful direction or signal given by the level 1 pilot or level 2 escort driver, in relation to the movement of the oversize vehicle.

8.15 Damage caused by oversize vehicles – driver of oversize vehicle or combination responsibility

- 8.15.1** The driver of an oversize vehicle or combination must immediately report any damage caused by an oversize vehicle or combination to the asset owner/s, and in the event it presents a dangerous situation, the local police.

8.16 Road closures / Restrictions

- 8.16.1** The driver of an oversize vehicle or combination must ensure they are aware of, and comply with, any temporary road closure/restrictions so described at the proposed time.

- 8.16.2** In the event of heavy or prolonged rain affecting the route, movements may be deferred until such day and time as may be determined by a representative of the Chief Executive. Current conditions of operation for excess dimension vehicles can be obtained from the Department of Transport and Main Roads website www.tmr.qld.gov.au. Select - Business and industry – Heavy vehicles – Excess mass and dimensions – Excess mass and dimensions conditions, then use the link to “Conditions of Operations Database.”

Additional information on current road closures and current roadworks are available on the following websites: www.131940.qld.gov.au or www.racq.com.au.

8.17 Required number of pilot and escort vehicles

- 8.17.1** The driver of any oversize vehicle or combination must ensure that the required number of pilot or escort vehicles is used to escort the oversize vehicle or combination.

8.18 Excess mass

- 8.18.1** If an oversize vehicle or combination exceeds the mass limits outlined in the *Transport Operations (Road Use Management – Mass, Dimensions and Loading) Regulation 2005*, the operation of the vehicle must comply with

the *Guideline for Operation of Excess Mass, Special Purpose Vehicles to 40 tonnes and Vehicles Carrying an Indivisible Item to 59.5 tonnes Form Number 11* or an Excess Mass Permit issued by the Department of Transport and Main Roads.

9. Approvals from other authorities

9.1 General dimension approvals

9.1.1 The driver of an oversize vehicle or combination has the overall responsibility:

- (a) for organising any required permits/authorisations; and
- (b) for the loading of the overdimensional vehicle to comply with any permits/authorisations issued; and
- (c) to ensure that the routes used by the overdimensional vehicle comply with any permits/authorisations issued; and
- (d) of any compliance or other conditions contained in any permits/authorisations which are relevant to the operation of the overdimensional vehicle.

9.1.2 A 'Letter of No Objection' is issued by Transport and Main Roads permit management offices. Relevant permit management offices are listed under the Transport and Main Roads website www.tmr.qld.gov.au. Select Business and industry/Heavy vehicles/Excess mass and dimension/Excess mass.

9.1.3 The driver of an oversize vehicle or combination must carry any document or information sheet (or a copy) issued by the relevant authority, which sets out the obligation imposed under a notice and it must be produced when requested by an authorised officer.

9.2 General dimension approvals from the Department of Transport and Main Roads

9.2.1 Where the width of an oversize vehicle or combination exceeds 4.6m, approval to travel on a route must be sought from the Department of Transport and Main Roads. Approval is given in the form of a 'Letter of No Objection'. The 'Letter of No Objection' is used to inform police and level 1 pilot/level 2 escort drivers that the proposed route has been assessed for suitability for the journey. Conditions of the 'Letter of No Objection' must be complied with.

9.3 General dimension approvals from Queensland Police Service

9.3.1 Where the dimensions of an oversize vehicle or combination listed in Table 5 are exceeded, approval to operate must be obtained from Queensland Police Service in the form of a police permit.

Further information and contact details can be found under the Queensland Police Service website www.police.qld.gov.au.

9.4 General dimension approvals from electrical authorities

- 9.4.1** Where the height dimension of an oversize vehicle or combination is likely to interfere with overhead wires or falls within the exclusion zone specified for overhead wires, approval to operate must be obtained from the relevant authority.

9.5 General dimension approvals from telecommunication authorities

- 9.5.1** Where the height dimension of an oversize vehicle or combination is likely to interfere with overhead wires, approval to operate must be obtained from the relevant authority.

9.6 General dimension approvals from Queensland Rail

- 9.6.1** Where the height dimension of an oversize vehicle or combination is likely to interfere with overhead wires or falls within the exclusion zone specified for overhead wires, approval to operate must be obtained from the relevant authority.

- 9.6.2** Where the width and length dimension of an oversize vehicle or combination exceeds specified dimensions, approval to operate must be obtained from the relevant authority.

9.7 General dimension approvals for any miscellaneous major risk factor

- 9.7.1** The person responsible for moving the load must contact the authority who owns or is in charge of the property when any miscellaneous major risk factor applies prior to the commencement of the journey, or otherwise the Queensland Police Service must be contacted.

10. Travel restrictions

The driver of an oversize vehicle or combination and level 1 pilot and level 2 escort vehicle drivers escorting oversize vehicles and combinations under this guideline must observe the following restrictions to the prescribed areas and roads:

10.1 City of Brisbane or any other city

- 10.1.1** A person must not drive an oversize vehicle or combination in the Brisbane City, Gold Coast City, or Central Business District of any other city between 7.00am and 9.00am and or between 4.00pm and 6.00pm on business days.

This restriction does not apply to:

- (a) vehicle combinations no longer than 25m and no wider than 2.5m, operating on authorised B-double routes; or

- (b) vehicle combinations no longer than 25m and no wider than 3.2m, operating on road train routes: or
- (c) a special purpose vehicle no wider than 3.5m provided the vehicle is travelling to or from a job site.

Note: Nighttime operations of oversize vehicles or combinations must comply with the requirements of section 7 'Nighttime travel – Trucks, trucks hauling a pig or dog or tag trailer, prime mover semi trailer combinations – do not require police permits.', of this guideline.

- 10.1.2 An oversize vehicle or combination more than 30m long or 4.6m wide is not permitted to operate between 9.00am and 4.00pm on a business day within the city of Brisbane.
- 10.1.3 An oversize vehicle or combinations more than 25m long or 3.5m wide are not permitted to operate in the Brisbane Central Traffic Area between 7.00am and 6.00pm on a business day.
- 10.1.4 The boundary's for Gold Coast City, Brisbane City, and Brisbane Central Traffic Area are detailed in the current UBD Street Directory or websites www.goldcoast.qld.gov.au and www.brisbane.qld.gov.au, respectively.
- 10.1.5 An oversize vehicle or combination is not permitted in the following areas:
 - (a) Pacific Motorway (South East Freeway and Riverside Expressway) north of its intersection with the Gateway Arterial Road; or
 - (b) Western Arterial Road from Miskin Street, Toowong to Stafford Road, Everton Park (Frederick Street, Rouen Street, Boundary Street, Kaye Street, MacGregor Terrace, Jubilee Terrace, Elimatta Drive, Stewart Road, Wardell Street, up to Lloyd St, or
 - (c) Houghton Highway Bridge and Ted Smout Bridge; or
 - (d) Clem 7 (North-South bypass) Tunnel.

10.2 Queensland – south east corner

- 10.2.1 An oversize vehicle or combination wider than 3.1m and/or longer than 25m is not permitted to travel on the roads within the south east corner between:
 - (a) 7.00am to sunset on Saturdays, Sundays and a statewide public holiday which falls on a weekday; or
 - (b) midday to sunset, the day prior to a statewide long weekend and 7.00am to sunset on each day of the long weekend.
- 10.2.2 Despite subsection 10.2.1 an oversize vehicle or combination exceeding 3.1m and up to 4.5m and no longer than 30m is permitted to travel on the roads within the south east corner, except the roads within the Brisbane Central Business District and the Brisbane Urban Corridor, between:

- (a) 7.00am to 10.00am on Saturdays, Sundays and statewide public holidays which fall on a weekday: or
- (b) 7.00am to 10.00am on each day of a long weekend.

Note: A long weekend is when a weekend joins a public holiday.

- 10.2.3** Despite 10.2.1 and 10.2.2 an oversize vehicle or combination exceeding 3.1m in width is permitted to travel on the Warrego Highway and Ipswich Road between Toowoomba and Rocklea (radius of 500m from Ipswich Road, Rocklea) from 10.00am - 4.00pm on Sundays and 10.00am (midday if the oversize vehicle or combination exceeds 3.5m in width) to sunset on a Saturday or a public holiday.
- 10.2.4** A reference to public holidays within this section (10.2) does not include the Easter and Christmas periods.

10.3 Statewide restrictions

- 10.3.1** The operator of an oversize vehicle or combination operating under this guideline are not permitted to operate on restricted roads in contravention to dimensions limits which exceed those specified for the particular roads in the "Conditions of Operation".

Current "Conditions of Operations" can be accessed via the Department of Transport and Main Roads web site at www.tmr.qld.gov.au; select Select - Business and industry – Heavy vehicles – Excess mass and dimensions – Excess mass and dimensions conditions, then use the link to “Conditions of Operations Database”.

- 10.3.2** The operator must ensure that the driver of an oversize vehicle or combination is aware of, and complies with, any temporary road closures which may affect the route being used.

Additional information on current road closures and current roadworks is available on the following websites: www.131940.qld.gov.au or www.racq.com.au.

10.4 Christmas and New Year restrictions

- 10.4.1** An oversize vehicle or combination is not permitted to travel throughout Queensland from 24 December to 02 January of the following year inclusive.

An oversize vehicle or combination which requires more than one pilot or escort vehicle is not permitted to travel throughout Queensland from 19 December to 02 January of the following year inclusive.

When Christmas Day falls on a Sunday or a Monday, restrictions applying to oversize vehicles and combinations commencing on the 24 December, will be extended to commence from 12 noon on the Friday prior to Christmas Day.

When 01 January falls on a Friday, restrictions applying to oversize vehicles and combinations will be extended to 11.59pm on 03 January of that year.

- 10.4.2** Despite subsection 10.4.1 a special purpose vehicle up to 3.5m in width is permitted to travel during the Christmas and New Year restrictions provided travel is not on any highway, motorway, or freeway, and the vehicle is travelling to and from a job site.

10.5 Easter restrictions

- 10.5.1** No movement throughout Queensland, of an oversize vehicle or combination, from Thursday before Easter to the Tuesday after Easter inclusive.

- 10.5.2** Despite subsection 10.5.1 a special purpose vehicle up to 3.5m in width is permitted to travel during the Easter restrictions provided travel is not on any highway, motorway, or freeway, and the vehicle is travelling to and from a job site.

10.6 Electrical authorities map – State of Queensland

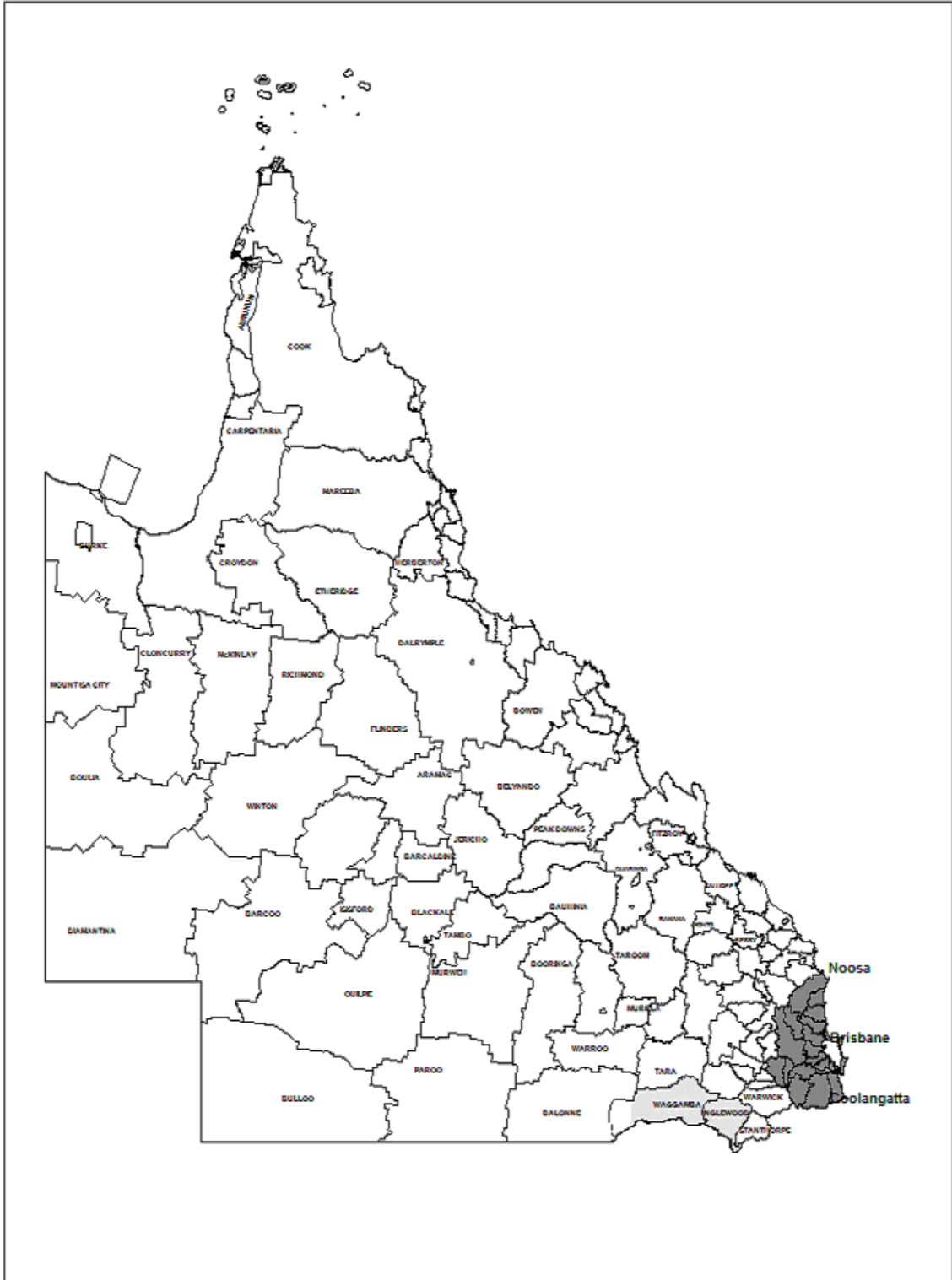

© MapInfo Australia Pty Ltd (2004). Based on [Dataset - State Digital Road Network (SDRN)] provided with the permission of MapInfo Australia Pty Ltd (2004). While every care is taken to ensure the accuracy of this data, MapInfo Aust Pty Ltd, Public Sector Mapping Authority Aust Pty and/or the State of Qld makes no representations or warranties about its accuracy, reliability, completeness or suitability for any particular purpose and disclaims all responsibility and all liability (including without limitation, liability in negligence) for all expenses, losses, damages (including indirect or consequential damage) and costs which you might incur as a result of the data being inaccurate or incomplete in any way and for any reason.

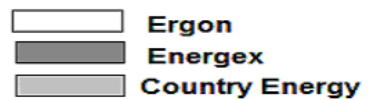

11. Warning devices for oversize vehicles or combinations and pilot/escort vehicles

11.1 Warning devices required when exceeding width

- 11.1.1 An oversize vehicle or combination that is wider than 2.5m must have:
- (a) one warning sign at its front; and
 - (b) one warning sign at the rear, or if it is carrying a rear projecting load, at the rear of the load; and
 - (c) four warning flags, with one flag fitted to each side of the front and rear of the vehicle, or if there is any projecting load at each side of both the front and rear of the projecting load.
- 11.1.2 An oversize vehicle or combination must display a warning light if it is wider than 3m.
- 11.1.3 A warning light must be operating when the oversize vehicle or combination is travelling or is stationary in a position that is likely to cause danger to other road users.
- 11.1.4 If a load projects more than 150mm beyond the sides of a vehicle or combination, and the projection is less than 500mm thick from top to bottom, there must be:
- (a) a warning light attached to the vehicle or combination; and
 - (b) at least two yellow rigid pieces of material (known as “delineators”), one attached to the front, and one to the rear of the load where it projects beyond the sides of the vehicle or combination.
- Note:** If the load projects more than 150mm beyond both sides of the vehicle there must be at least 4 delineators, one on each side at the front and one on each side at the rear.
- 11.1.5 An oversize vehicle or combination wider than 2.5m or longer than 25m in length must have its low beam headlights on while travelling.

11.2 Warning devices required when exceeding length

- 11.2.1 An oversize vehicle or combination together with any load that exceeds 22m in length but does not exceed 2.5m in width, must have one warning sign at the rear of the vehicle. If the loads projects to the rear, the sign must be at the rear of the load.

11.3 Warning devices required when exceeding height

- 11.3.1 An oversize vehicle or combination together with any load, that does not exceed 2.5m in width but is higher than 4.6m, must have:
- (a) one warning sign at its front; and
 - (b) one warning sign at its rear or if it is carrying a rear projecting load, at the rear of any projecting load if the vehicle exceeds 22m in length.

Note: This subsection does not apply if the vehicle is a B-double or road train.

11.4 Warning devices required when exceeding rear overhang

- 11.4.1** If loading or equipment projects more than 5.5m behind the rear overhang line of a prime mover semitrailer combination, the sides of the projection must be highlighted with a warning pattern.

11.5 Warning devices required when exceeding forward projection

- 11.5.1** If equipment projects more than 1.2m in front of the body of a special purpose vehicle, the sides of the projection must be highlighted with a warning pattern, or if due to the construction of the projection, to the maximum practical space available.

11.6 Additional warning devices required during nighttime travel

- 11.6.1** When operating out of daylight hours, any oversize vehicle or combination must comply with all applicable requirements for warning devices specified in sections 11.1, 11.2, 11.3, 11.4 and 11.5 in addition to the requirements in this section.

- 11.6.2** An oversize vehicle or combination must display:

(a) side markers - yellow lights to the front and red or yellow lights to the rear no more than 2m apart along both sides of the oversize vehicle and along any front and rear projection; and

Note: side markers must start and finish at the end of the projecting load.

(b) rear clearance lights - two red lights fixed to the rear of any projecting load within 400mm of each side of the load, and at least 1m but no more than 2.1m above the ground.

(c) all lights must be Australian Design Rule (ADR) compliant.

Note: Please refer to Section 3 of this guideline for the definition of 'oversize'.

- 11.6.3** A warning light must be displayed if the oversize vehicle or combination is wider than 2.5m or longer than 22m.

- 11.6.4** If a load or equipment is higher than 5.0m, it must have a white light adequate to illuminate the front of the highest point of the vehicle or load. The light must be directed or shielded so as not to dazzle any driver.

- 11.6.5** If equipment projects more than 1.2m in front of the body of a special purpose vehicle, a yellow light must be fixed on each side of the projection, mounted as far forward as possible and shielded from the driver's view. Both lights must be visible to traffic approaching the vehicle from its front, and at least one of the lights must be visible to any traffic approaching the vehicle from either side.

- 11.6.6** When the width of an article is wider than 6.1m, the outer edges of the article must be defined by flashing amber lights. The beam of the flashing amber lights must be forward facing from the front of the load and rearward facing from the rear of the load.

11.7 Warning devices required for pilot and escort vehicles

Pilot and escort vehicles must have the following warning devices;

- (a) a warning sign on its roof; and
 - (b) a warning light.
- 11.7.1** Any warning light which a pilot or escort vehicle is required to have must be operating when the vehicle is accompanying an oversize vehicle or combination.
- 11.7.2** A warning light must be attached for a pilot or escort vehicle:
- (a) above or below the warning sign; or
 - (b) at each side of the warning sign.
- 11.7.3** Additionally, an escort vehicle must be fitted with two wig wag lights at the front of the vehicle and have the wig wag lights operating only during the day when escorting an oversize vehicle or combination.
- 11.7.4** The low beam headlights on a pilot or escort vehicle must be switched on when it is accompanying an oversize vehicle or combination.
- 11.7.5** An escort vehicle must carry 6 traffic cones or triangles.

12. Warning device specifications for oversize vehicles or combinations and pilot/escort vehicles

12.1 Warning flags

- 12.1.1** A warning flag must:
- (a) be at least 450mm long and at least 450mm wide; and
 - (b) be brightly coloured red, yellow, or red and yellow.

12.2 Warning lights

- 12.2.1** A warning light must, when operating:
- (a) emit a rotating, flashing yellow coloured light; and
 - (b) flash between 120 and 200 times a minute; and
 - (c) have a power of at least 55 watts; and
 - (d) not be a strobe light.

12.2.2 A warning light, when operating must be clearly visible at a distance of 500m in all directions, or be supplemented by one or more additional warning lights so that the emitting light from at least one of them is clearly visible at a distance of 500m in any direction.

12.2.3 Despite subsection 12.2.2, in the case of a pilot or escort vehicle travelling directly in front of an oversize vehicle or combination, a filter may be placed behind the warning light on the pilot or escort vehicle, to reduce the intensity of the light directed to the driver of the oversize vehicle or combination.

12.3 Wig wag lights for escort vehicles only

12.3.1 An escort vehicle's wig wag lights when operating must:

- (a) emit a yellow or white coloured light; and
- (b) not be a strobe light; and
- (c) have a power of at least 55 watts; and
- (d) flash alternatively to give a wig wag effect.

12.3.2 Wig wag lights must be installed in the following position:

- (a) fitted symmetrically (same position on both sides of the vehicle); and
- (b) no higher than the top of dipped beam lamp; and
- (c) not less than 250mm from the ground; and
- (d) mounted at the front of the vehicle so as to not obstruct the driver's view; and
- (e) the outside edge of the lights is to be no further than 400mm from the side of the car.

12.4 Delineators

12.4.1 A delineator must:

- (a) be at least 300mm long and at least 300mm wide; and
- (b) comply with Class 1 or 2 of Australian Standard AS 1906 *Retro-reflective Materials and Devices for Road Traffic Control Purposes*.

12.4.2 A delineator must be attached so that its reflective surface is facing:

- (a) forward of the vehicle, if at the front of the projection; and
- (b) rearward of the vehicle, if at the rear of the projection.

12.5 Warning signs

12.5.1 A warning sign for oversize vehicles or combinations and pilot/escort vehicles must comply with the following specifications:

- (a) the face must have a yellow surface which complies with Class 1 or 2 of Australian Standard AS 1906 *Retro-reflective Materials and Devices for Road Traffic Control Purposes*; and
- (b) the face of the warning sign must have a black border at least 20mm wide; and
- (c) the outermost edge of the border must be set at least 10mm in from the edge of the sign unless the sign has been made with a box edge; and
- (d) the warning sign must have its manufacturer's name or trademark permanently marked in letters at least 3mm but not more than 10mm high in any visible location on the sign. The manufacturer's marking may appear in any visible location of the sign.

12.5.2 A warning sign must be made of:

- (a) a rigid, flat, weatherproof material; or
- (b) despite 12.5.2 (a), the rear sign on an oversize vehicle or combination may be made of flexible material if the load is unsuitable for a rigid sign.

Note: Front signs on an oversize vehicle combination must not be made of a flexible material.

12.5.3 A warning sign on an oversize vehicle or combination must have a face showing:

- (a) the word 'OVERSIZE', in black upper-case lettering, conforming with Australian Standard AS 1744, *Forms of Letters and Numerals for Road Signs, in typeface Series C(N)*; and
- (b) the letters must be at least 200mm high; and
- (c) the top and bottom of the lettering must be at least 125mm from the top and bottom of the sign, respectively.

12.5.4 A warning sign on an oversize vehicle or combination must be at least 1200mm long and at least 450mm high.

12.5.5 A warning sign which splits in two parts on an oversize vehicle or combination must have a combined length of at least 1200mm.

12.5.6 A warning sign which is split in two parts on an oversize vehicle or combination must have:

- (a) the part mounted on the left showing the letters 'OVER'; and

- (b) the part mounted on the right showing the letters 'SIZE'; and
- (c) there must be no border between the two parts.

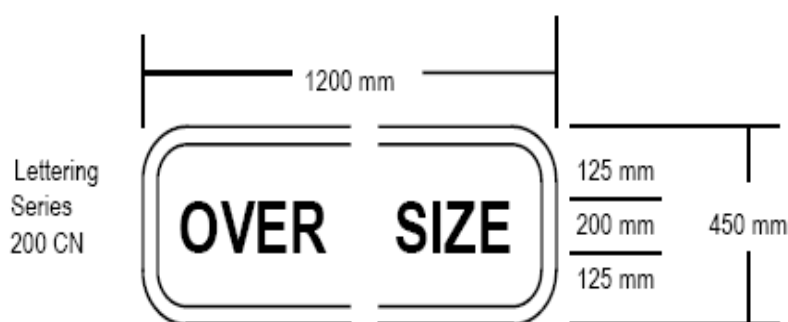

12.5.7 A warning sign on an oversize vehicle or combination must be mounted:

- (a) in a way unlikely to be dislodged; and
- (b) the lower edge of the sign must be:
 - (i) above the bottom of the bumper bar or bull bar; or
 - (ii) if there is no bumper bar, at least 500mm from the ground; and
- (c) if the sign is split into two parts, each part must be fitted at the same height as the other.

12.5.8 A warning sign on a pilot or escort vehicle must have faces showing:

- (a) the words 'OVERSIZE' and 'LOAD AHEAD' must be on the front and rear of the sign;
- (b) the word 'OVERSIZE', in black upper case lettering at least 200mm high, conforming with Australian Standard AS 1744, *Forms of Letters and Numerals for Road Signs*, in typeface Series C(N);
- (c) the words 'LOAD AHEAD', in black upper case lettering at least 100mm high, conforming with Australian Standard AS 1744, *Forms of Letters and Numerals for Road Signs*, in typeface Series D(N);
- (d) the bottom of the lettering of the word 'OVERSIZE' must be at least 300mm from the bottom of the sign;
- (e) the bottom of the words 'LOAD AHEAD' must be at least 100mm from the bottom of the sign; and
- (f) the word 'LOAD AHEAD' must be at least 100mm below the word 'OVERSIZE'.

12.5.9 In spite of subsection 12.5.4, a warning sign on a pilot or escort vehicle must be at least 1200mm long and at least 600mm high.

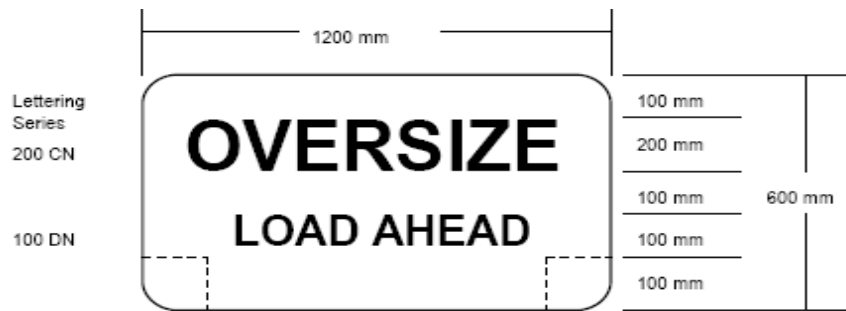

12.5.10 A warning sign must be mounted on a pilot or escort vehicle in the following way:

- (a) central position above the vehicle's roof; and
- (b) leaning back so that the top edge of the sign is not more than 200mm from the upright position.

12.5.11 A warning sign on pilot/escort vehicles may have bottom corner cut-outs not more than 150mm wide and not more than 100mm high if they are needed for mounting the warning lights.

12.5.12 A warning sign must be clearly visible and legible to other road users.

12.5.13 A warning sign on a pilot/escort vehicle must be entirely covered, removed, or laid flat so as not to be read by other road users when the oversize vehicle or combination is not exceeding regulated dimensions.

12.6 Warning pattern

12.6.1 A warning pattern must:

- (a) cover an area of at least 0.16 sq m (e.g. 100mm x 1600mm); or
- (b) if less space is available, due to the construction of the projection, cover the maximum practical space available.

12.6.2 A warning pattern must consist of diagonal stripes at least 150mm wide and alternately coloured:

- (a) red and white; or
- (b) black and white

12.7 Traffic cones

12.7.1 Traffic cones must comply with the Australian Standard or other equivalent which equals the Australian Standard.

13. Pilot/escort, vehicle and operating requirements

These requirements are for pilot and escort vehicles other than police vehicles and police motor cycles.

13.1 Pilot and escort vehicle requirements

- 13.1.1 A pilot or escort vehicle must have:
- (a) four or more wheels; and
 - (b) a GVM of 4.5t or less for escort vehicles; or
 - (c) a gross vehicle mass (GVM) of 6.5t or less in the case of a rear pilot vehicle if two pilot vehicles are required; or 4.5t or less in any other case.
- 13.1.2 A pilot or escort vehicle must not:
- (a) tow a trailer, any other vehicle; or
 - (b) carry a load, but it may carry tools, equipment, or substances for use in connection with the oversize vehicle or combination that it is accompanying or for restraining the load on that vehicle or combination.

13.2 Lead pilot or escort vehicles

- 13.2.1 When there is more than one pilot or escort vehicle required, the pilot or escort vehicle directly in front of the oversize vehicle or combination is classified as the lead pilot or escort vehicle. When there is a requirement for only one pilot or escort vehicle, that vehicle is classified as the lead pilot or escort vehicle.
- 13.2.2 Where a police vehicle forms part of the escort, the police will be in charge of the move.
- 13.2.3 Police escorts are only involved when a police permit has been obtained for the movement.

13.3 Positioning of pilot/escort and assisting vehicles

- 13.3.1 The tables below indicate the positions of pilot or escort vehicles and police escort vehicles when accompanying an oversize vehicle or combination.
- 13.3.2 The relevant maximum distances may be varied, by a level 1 pilot or level 2 escort operator or police officer, to take into consideration a particular traffic or road condition; the speed of travel of the oversize vehicle; the maximum speed limit; the location; traffic volumes; weather conditions; the approaching speed; the road surface; climatic conditions; braking distances, etc.
Special attention should be given to the risks associated with the transportation of oversize loads on two lane roads.

13.3.3 The tables include:

- 13.A One pilot or escort vehicle.
- 13.B Two pilot or escort vehicles.
- 13.C One pilot or escort vehicle and one police vehicle.
- 13.D Three pilot or escort vehicles.
- 13.E Two pilot or escort vehicles and one police vehicle.
- 13.F Two pilot or escort vehicles and two police vehicles.
- 13.G Two pilot or escort vehicles and more than two police vehicles.
- 13.H Convoy travel arrangements for three pilot or escort vehicles and one or more police vehicles.

13.A One pilot or escort vehicle.

Location	Maximum Distance
Built-up area	300m in front of the oversize vehicle
Built-up area (dual carriageway)	300m behind the oversize vehicle
Outside built-up area (max. posted speed limit is less or equal to 80km/h)	between 300m and 1000m in front of oversize vehicle
Outside built-up area (max. posted speed limit is in excess of 80km/h)	between 1000m and 1500m in front of oversize vehicle

Note: If length is the only excess dimension, the pilot or escort vehicle is to travel at a maximum distance of 300m behind the oversize vehicle.

13.B Two pilot or escort vehicles.

Location	Vehicle	Maximum Distance
Built-up area (single and dual carriageway)	one escort or pilot vehicle	300m in front of the oversize vehicle
	one escort or pilot vehicle	300m behind the oversize vehicle
Outside built-up area (max. posted speed limit is less or equal to 80km/h)	one escort or pilot vehicle	between 500m and 1000m in front of the oversize vehicle
	one escort or pilot vehicle	300m behind the oversize vehicle
Outside built-up area (max. posted speed limit is in excess of 80km/h)	one escort or pilot vehicle	between 1000m and 1500m in front of the oversize vehicle
	one escort or pilot vehicle	500m behind the oversize vehicle

13.C One pilot or escort vehicle and one police vehicle.

Location	Vehicle	Maximum Distance
Built-up area	one escort or pilot vehicle	300m in front of the oversized vehicle
	one police vehicle	300m behind the oversized vehicle
Built-up area (dual carriageway)	one escort or pilot vehicle	300m in front of the oversized vehicle
	one police vehicle	300m behind the oversized vehicle
Outside built-up area (max. posted speed limit is less or equal to 80km/h)	one escort or pilot vehicle	between 500m and 1000m in front of the oversized vehicle
	one police vehicle	either 200m in front of the oversized vehicle or 300m behind the oversized vehicle
Outside built-up area (max. posted speed limit is in excess of 80km/h)	one escort or pilot vehicle	between 1000m and 1500m in front of the oversized vehicle
	one police vehicle	either 500m in front of the oversized vehicle or 200m behind the oversized vehicle

13.D Three pilot or escort vehicles.

Location	Vehicle	Maximum Distance
Built-up area (single and dual carriageway)	one escort or pilot vehicle	400m in front of the oversized vehicle
	one escort or pilot vehicle	300m behind the oversized vehicle
	one escort or pilot vehicle	200m in front of the oversized vehicle
Outside built-up area (max. posted speed limit is less or equal to 80km/h)	one escort or pilot vehicle	between 500m and 1000m in front of the oversized vehicle
	one escort or pilot vehicle	300m behind the oversized vehicle
	one escort or pilot vehicle	200m in front of the oversized vehicle
Outside built-up area (max. posted speed limit is in excess of 80km/h)	one escort or pilot vehicle	Between 1000m and 1500m in front of the oversized vehicle
	one escort or pilot vehicle	300m behind the oversized vehicle
	one escort or pilot vehicle	500m in front of the oversized vehicle

13.E Two pilot or escort vehicles and one police vehicle.

Location	Vehicle	Maximum Distance
Built-up area (single and dual carriageway)	one escort or pilot vehicle	200m in front of the police vehicle
	one escort or pilot vehicle	300m behind the oversize vehicle
	one police vehicle	200m in front of the oversize vehicle
Outside built-up area (max. posted speed limit is less or equal to 80km/h)	one escort or pilot vehicle	between 500m and 1000m in front of the oversize vehicle
	one escort or pilot vehicle	300m behind the oversize vehicle
	one police vehicle	200m in front of the oversize vehicle
Outside built-up area (max. posted speed limit is in excess of 80km/h)	one escort or pilot vehicle	between 1000m and 1500m in front of the oversize vehicle
	one escort or pilot vehicle	300m behind the oversize vehicle
	one police vehicle	500m in front of the oversize vehicle

13.F Two pilot or escort vehicles and two police vehicles.

Location	Vehicle	Maximum Distance
Built-up area (single and dual carriageway)	one escort or pilot vehicle	200m in front of the first police vehicle
	one escort or pilot vehicle	300m behind the oversize vehicle
	one police vehicle	100m in front of the oversize vehicle
	one police vehicle	either 200m behind the oversize vehicle or 300m in front of the oversize vehicle
Outside built-up area (max. posted speed limit is less or equal to 80km/h)	one escort or pilot vehicle	between 1000m and 1500m in front of the oversize vehicle
	one escort or pilot vehicle	300m behind the oversize vehicle
	one police vehicle	200m in front of the oversize vehicle
	other police vehicle	either 200m behind the oversize vehicle or 800m to 1200m in front of the oversize vehicle, but behind the leading escort or pilot vehicle
Outside built-up area (max. posted speed limit is in excess of 80km/h)	one escort or pilot vehicle	between 1500m and 2000m in front of the oversize vehicle
	one escort or pilot vehicle	300m behind the oversize vehicle
	one police vehicle	500m in front of the oversize vehicle
	one police vehicle	either 200m behind the oversize vehicle or 1300m to 1800m in front of the oversize vehicle, but behind the leading escort or pilot vehicle

13.G Two pilot or escort vehicles and more than two police vehicles. Specific number of police vehicles as per police permit.

Location	Vehicle	Maximum Distance
Built-up area (single and dual carriageway)	one escort or pilot vehicle	200m in front of the first police vehicle
	one escort or pilot vehicle	300m behind the oversize vehicle
	one police vehicle	100m in front of the oversize vehicle
	one police vehicle	300m in front of the oversize vehicle
	one police vehicle	200m behind the oversize vehicle
	other police vehicles	as considered appropriate
Outside built-up area (max. posted speed limit is less or equal to 80km/h)	one escort or pilot vehicle	between 1000m and 1500m in front of the oversize vehicle
	one escort or pilot vehicle	300m behind the oversize vehicle
	one police vehicle	200m in front of the oversize vehicle
	one police vehicle	between 800m to 1200m in front of the oversize vehicle, but behind the leading escort or pilot vehicle
	one police vehicle	200m behind the oversize vehicle
	other police vehicles	as considered appropriate
Outside built-up area (max. posted speed limit is in excess of 80km/h)	one escort or pilot vehicle	between 1500m and 2000m in front of the oversize vehicle
	one escort or pilot vehicle	300m behind the oversize vehicle
	one police vehicle	500m in front of the oversize vehicle
	one police vehicle	between 1300m to 1800m in front of the oversize vehicle, but behind the leading escort or pilot vehicle
	one police vehicle	200m behind the oversize vehicle
	other police vehicles	as considered appropriate

13.H Convoy travel arrangements for three pilot or escort vehicles and one or more police vehicles. Specific numbers of police vehicles as per police permit.

Location	Vehicle	Maximum Distance
Built-up area (single and dual carriageway)	one escort or pilot vehicle	200m in front of the first police vehicle
	one escort or pilot vehicle	300m behind the last oversized vehicle
	one escort or pilot vehicle	100m behind the first oversized vehicle and 100m in front of the second oversized vehicle
	one police vehicle	200m in front of the first oversized vehicle
	other police vehicles	either 300m in front of the first oversized vehicle, 200m behind the last oversized vehicle, or as considered appropriate
Outside built-up area (max. posted speed limit is less or equal to 80km/h)	one escort or pilot vehicle	between 1000m and 1500m in front of the first oversized vehicle
	one escort or pilot vehicle	300m behind the last oversized vehicle
	one escort or pilot vehicle	100m behind the first oversized vehicle and 100m in front of the second oversized vehicle
	one police vehicle	200m in front of the first oversized vehicle
	other police vehicles	either between 800m to 1200m in front of the first oversized vehicle, 200m behind the last oversized vehicle, or as considered appropriate
Outside built-up area (max. posted speed limit is in excess of 80km/h)	one escort or pilot vehicle	between 1500m and 2000m in front of the oversized vehicle
	one escort or pilot vehicle	800m behind the last oversized vehicle
	one escort or pilot vehicle	100m behind the first oversized vehicle and 100m in front of the second oversized vehicle
	one police vehicle	500m in front of the oversized first vehicle
	other police vehicles	either between 1300m to 1800m in front of the oversized vehicles, 200m behind the last oversized vehicles, or as considered appropriate

- 13.3.4** Additional vehicles required to accompany an oversize vehicle or combination as a result of requirements from permits and other authorities (railway, Telstra etc) should travel where appropriate behind the oversize vehicle or combination and in front of the rear pilot or escort vehicles until they are to be used to assist in the movement of the oversize or combination as determined by the level 1 pilot or level 2 escort operator.

14. Level 1 pilot and level 2 escort driver requirements

14.1 Level 1 pilot and level 2 escort vehicle driver requirements

- 14.1.1** The driver of a pilot or escort vehicle must not operate a vehicle as a pilot or escort vehicle unless:
- (a)** that person holds accreditation at level '1' or '2' to undertake the duties; or
 - (b)** in the case of an escort vehicle, the person must be accredited to level '2'; or
 - (c)** that person is approved to operate under the mutual recognition provisions of this guideline.
- 14.1.2** The driver of any pilot or escort vehicle cannot authorise themselves or anyone else to disobey any traffic regulation.
- 14.1.3** Level 1 pilot or level 2 escort drivers must inform themselves of the dimensions, warning devices, driver requirements and relevant vehicle operational requirements of any oversize vehicle as provided by this guideline prior to the movement of the oversize vehicle.
- 14.1.4** A level 1 pilot or level 2 escort driver must not accompany an oversize vehicle or combination except:
- (a)** where the pilot or escort operation complies with the requirements of this guideline, including the travel restrictions outlined in section 14 of this guideline; and
 - (b)** where the oversize vehicle or combination is authorised to move by virtue of permit, the conditions of that permit are met; and
 - (c)** in compliance with any other lawful authority, the conditions of that authority is met.
- 14.1.5** Level 1 pilot and level 2 escort vehicle drivers must ensure that the route nominated is trafficable for the oversize vehicle or combination so described at the applicable time.

14.2 Communication responsibilities

- 14.2.1** All persons involved in the operation of an oversize vehicle or combination and any other entity associated with the movement must ensure they have the appropriate equipment to maintain two way radio communication between all level 1 pilots, level 2 escorts, police officers and the oversize vehicle, and each of them at all times during the pilot or escort operation.

14.3 Damage caused by oversize vehicles

- 14.3.1** The driver of a pilot or escort vehicle accompanying an oversize vehicle or combination who is aware of any damage an oversize vehicle or combination has caused, must as soon as practical, notify the driver of the oversize vehicle or combination.

14.4 Record of movement

- 14.4.1** This section does not apply in relation to a journey undertaken as a pilot or escort for a vehicle for which a police permit has been obtained and a police officer is in attendance for the entire route or movement.
- 14.4.2** A record of movement must be completed for any journey or part of a journey if no police are present.
- 14.4.3** The level 1 pilot or level 2 escort driver must complete a record of movement for each journey undertaken as an escort for an oversize vehicle or combination.
- 14.4.4** Before escorting an oversize vehicle or combination on a journey, the lead level 1 pilot or level 2 escort driver must give a copy of the record of movement to the driver of the oversize vehicle or combination.
- 14.4.5** Once issued, the record of movement authorises the movement of the oversize vehicle or combination providing the pilot or escort operation is carried out in accordance with the requirements of this guideline at all times.
- 14.4.6** The level 1 pilot or level 2 escort driver who completed the record of movement must keep a copy of the record in the escort vehicle during the time the oversize vehicle or combination is being escorted. The copy of the record must be produced when required by a police officer or an authorised officer.
- 14.4.7** When more than one escort is required to accompany the oversize vehicle or combination, the lead level 1 pilot or level 2 escort driver at the commencement of the journey is required to complete the record of movement.

14.5 No travel in low visibility

- 14.5.1** The driver of a level 1 pilot or level 2 escort driver must not accompany an oversize vehicle or combination, if due to circumstances such as fog, heavy rain, smoke, dust, or insect plague:

(a) visibility is less than 250m in the daytime; or

- (b) the headlights of a vehicle approaching within 250m could not be seen at nighttime; or
- (c) visibility is sufficiently restricted that the safety of the pilot or escort operation, or other road users may be comprised.

14.5.2 If an oversize vehicle or combination is being escorted by a pilot or escort vehicle, the level 1 pilot or level 2 escort driver must direct the driver of the oversize vehicle or combination to drive to the nearest safe parking area until visibility improves.

14.6 Hand gestures

The powers of an accredited level 2 escort driver provided by Part 2 of the *Transport Operations (Road Use Management – Accreditation and Other Provisions) Regulation 2005* are further restricted by the following.

14.6.1 A level 2 escort driver must only use gestures when:

- (a) the escort vehicle is in motion; and
- (b) no other vehicle is passing, overtaking or within 50m of the escort vehicle; and
- (c) the driver of the escort vehicle can maintain full control over the vehicle at all times; and
- (d) in the hours of darkness an illuminated wand showing an amber or orange light is used; and
- (e) road conditions are suitable, e.g: no loose or slippery road surfaces, corners, corrugations, or adverse weather conditions are likely to cause a risk; and
- (f) the gesture is clearly displayed and as required; and
- (g) the driver displays a gesture as outlined within subsection 14.6.2.

14.6.2 The driver of an escort vehicle may only display the following gestures when the driver is of the opinion that the driver of an approaching vehicle does not appear to be slowing to a speed appropriate for the prevailing conditions, moving from the centre line, providing a clear passage or giving way to the excess dimensional vehicle:

- (a) a hand gesture, without a sign as indicated in section 15.5 of this guideline 'Directing Traffic to Proceed', to move traffic; and
- (b) a hand gesture, without a sign as indicated in section 15.6 of this guideline 'Warning Traffic to Slow Down', to slow traffic; and
- (c) a hand gesture with the arm horizontal to the road surface and point the hand towards the off-side edge of the roadway.

14.6.3 The gesture is not considered a signal and can only be used in conjunction with the lighting conditions imposed by the requirements contained within this guideline for an escort driver.

14.7 Interstate level 1 pilot and level 2 escort driver - mutual recognition

14.7.1 Level 1 pilots or level 2 escort drivers who are registered or licensed or certified or accredited in another state or territory may operate under this guideline under the following conditions:

- (a) operation is restricted to the level of authority for which they are permitted to operate in their state or territory; and
- (b) they hold and have held for a total of at least 3 years during the 5 years before the day of entry into Queensland, a provisional or open licence to drive a motor vehicle; and
- (c) operations are conducted in accordance with the terms and conditions contained in this guideline; and
- (d) Level 1 pilot or level 2 escort drivers provide evidence of achieved competency (including the ability to perform traffic control duties if a level 2 escort driver) if requested to do so by an authorised officer.

14.7.2 Pilot drivers who do not have accreditation and reside in any jurisdiction that does not have formal accreditation are permitted to carry out level 1 pilot operations in Queensland provided:

- (a) the journey has commenced outside of Queensland; and
- (b) they hold and have held for a total of at least 3 years during the 5 years before the day of entry into Queensland, a provisional or open licence to drive a motor vehicle; and
- (c) they currently reside in the state or territory in which the drivers licence was issued; and
- (d) they are able to provide evidence that they normally carry out pilot or escort operations as a means of earning a livelihood in their state or territory; and
- (e) only permitted to pilot a load going out of Queensland with the same transport company in which they piloted into Queensland.

15. Traffic control recommendations

These recommendations are for level 2 escort vehicle drivers other than police officers.

15.1 Duties of level 2 escort vehicle driver performing traffic control

15.1.1 A level 2 escort vehicle driver performing traffic control is limited to using hand signals in conjunction with a bat/banner to direct drivers, riders, and pedestrians.

15.1.2 A level 2 escort vehicle driver is permitted to perform traffic control duties only when accompanying an oversize vehicle or combination.

15.2 Position of level 2 escort vehicle driver during traffic control

- 15.2.1** When performing traffic control, a level 2 escort vehicle driver should be standing in a position:
- (a) facing the traffic; and
 - (b) just outside the travelled path; and
 - (c) so that oncoming traffic approximately 150m away, can see the controller; and
 - (d) that will not obstruct road user's view of other signs and devices or be him/herself obscured by them; and
 - (e) so that a clear escape path is available.
- 15.2.2** A level 2 escort vehicle driver should be standing a distance of at least 100m in front of the oversize vehicle or combination at the point where the oversize vehicle clears the obstacle.
- 15.2.3** A level 2 escort vehicle driver should be standing a distance of at least 100m behind the escort vehicle.
- 15.2.4** In spite of subsections 15.2.2 and 15.2.3, a level 2 escort vehicle driver is permitted to stand in a position closer to the escort vehicle and or the oversize vehicle or combination, in urban areas, low speed limits or in special circumstances when in the opinion of the level 2 escort vehicle driver, a lesser distance is more appropriate.
- The level 2 escort vehicle driver must ensure the safety of other road users when controlling traffic from a position which does not comply with subsections 15.2.2 and 15.2.3.
- 15.2.5** A level 2 escort vehicle driver should hold the bat at an angle of 90 degrees to the road.
- 15.2.6** During the hours of darkness, the operations area should be illuminated. Such illumination shall be placed so as to not shine into the eyes of approaching drivers.

15.3 Position of an escort vehicle during traffic control

- 15.3.1** When performing traffic control, a level 2 escort vehicle driver should place the escort vehicle:
- (a) facing the traffic; and
 - (b) just outside the travelled path. In special circumstances, the escort vehicle may be placed in another position, where the escort vehicle driver considers it is safe for other road users; and
 - (c) so that the vehicle is able to be seen approximately 150m away from all directions; and
 - (d) so that it will not obstruct any other road user's view of other signs and devices.

- 15.3.2** An escort vehicle should be placed at a distance of approximately 200m in front of the oversize vehicle or combination at the point where the oversize vehicle clears the obstacle.
- 15.3.3** In spite of subsection 15.3.2 a level 2 escort vehicle driver is permitted to place the escort vehicle in a position closer to the oversize vehicle or combination in urban areas, low speed limits or in special circumstances when, in the opinion of the level 2 escort vehicle driver, a lesser distance is more appropriate.
- 15.3.4** The level 2 escort vehicle driver must ensure the safety of other road users when placing the escort vehicle in a position which does not comply with subsection 15.3.2.

15.4 Warning traffic to stop

- 15.4.1** Wait for a suitable break in the traffic before stopping the traffic.
- 15.4.2** Hold the bat with 'STOP' facing the oncoming traffic.
- 15.4.3** Raise the free hand into the stop signal position with the palm towards the traffic.
- 15.4.4** Once traffic has stopped, a traffic controller should change position if necessary so as to be clearly visible to further traffic.
- 15.4.5** A level 2 escort vehicle driver should stand clear of the traffic before allowing it to proceed.

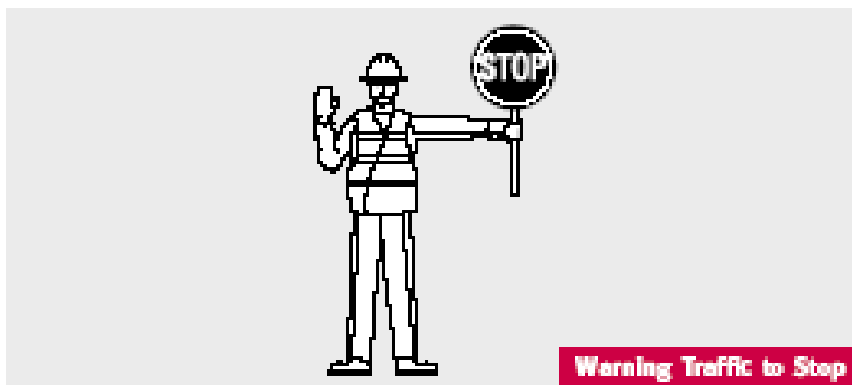

15.5 Directing traffic to proceed

- 15.5.1 When signalling traffic to proceed, turn the bat to show 'SLOW' facing the oncoming traffic.
- 15.5.2 Signal with the free hand, using a sweeping motion in the direction the traffic is to move.
- 15.5.3 Do not wave the sign to signal traffic to proceed.

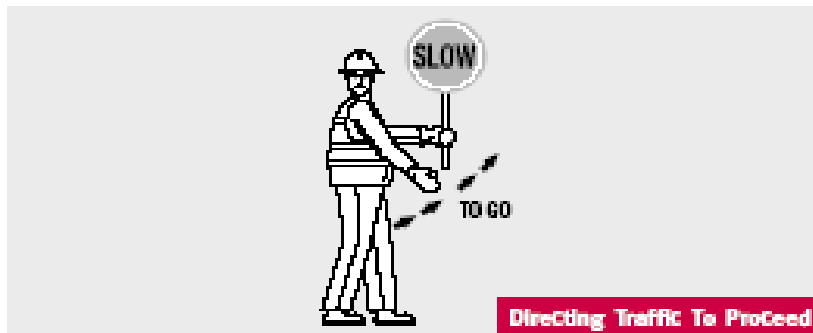

15.6 Warning traffic to slow down

- 15.6.1 Hold the bat with 'SLOW' facing the oncoming traffic.
- 15.6.2 Signal with the free hand in an up and down motion to slow down.
- 15.6.3 Do not wave the sign to signal traffic to slow down.



15.7 Clothing requirements for traffic controllers

- 15.7.1 A vest must be worn by a level 2 escort vehicle driver performing traffic control duties.
- 15.7.2 The vest shall be worn as an outer garment and shall not be covered by any other garment or article.

- 15.7.3** A vest must be constructed of the following material and design:
- (a) a vest must be fluorescent lime/yellow. The word 'PILOT', in minimum 80mm high upper case lettering, must be centrally placed across the full width of the front and back, on retro-reflective material that is fluorescent red or orange colour during daytime and white in colour when exposed to artificial light; and
 - (b) the word 'PILOT' must be placed in the lime/yellow section of the garment; and
 - (c) a 100mm wide strip of the red/orange retro-reflective material shall be located around the base (hip area) of the vest with a 50mm wide strip located around the high chest area of the vest, which is to be edged with a 10mm strip of silver/white retro-reflective binding; and
 - (d) the vest colours, fabric fluorescence, and retro-reflectivity are to meet the requirements of AS 1906.4 - *Materials and Devices for Road Traffic Control Purposes, Part 4*.
- 15.7.4** A vest must be kept in good clean condition so that it can be easily visible during daytime and during hours of darkness.
- 15.7.5** Head protection if worn by a level 2 escort vehicle driver performing traffic control duties must have one of the following types of head protection:
- (a) a hat or cap that is either of a fluorescent red/orange colour with either a stiff brim at least 80mm wide and or a legionnaire type neck flap made of fluorescent fabric; or
 - (b) a highly visible safety helmet or cap complying with AS 1800 – *Safety Helmets*, with the option of an attached brim at least 80mm wide, and or a legionnaire type neck flap made of fluorescent fabric.
- 15.7.6** Clothing must be neat, clean, and highly visible.

15.8 Traffic control signals and equipment

- 15.8.1** A traffic control sign or bat shall consist of either:
- (a) STOP or SLOW bat, with a STOP banner in white reflectorised letters and border on a red reflectorised background on one side, and a SLOW banner in black letters and border on a yellow background on the other side; or
 - (b) STOP or STOP bat, with a STOP banner in white reflectorised letters and border on a red reflectorised background on both sides; or (May be used for short length jobs where drivers may be confused if they can read a STOP sign and a SLOW sign at the same time during traffic control operations;) or
 - (c) SLOW or SLOW bat, with a SLOW banner in black letters and border on a yellow background on both sides.
(May be used to slow traffic approaching from both directions at the same time; during restricted two-way operations.)

- 15.8.2** A traffic control sign or bat must be 450mm diameter or 600mm diameter and suitable for daytime use and for use during hours of darkness.
- 15.8.3** Reflectorised materials used for a traffic control sign or bat shall:
- (a) comply with AS 1906.1 – *Retro-reflective Materials and Devices for Road Traffic Control Purposes Part 1: Retroreflective Materials*; and
 - (b) meet or exceed the abovementioned standard; and
 - (c) only be covered by any clear protective overlay film, provided the retro-reflective properties of the base material are not reduced by more than 10 percent and the film shall not reflect light that will detract from the light reflected from the base material.
-